

Evaluation of optimized PAPR of OFDM signal by using SLM technique

¹Biswajit Basak, ²Mousumi De

¹Assistant Professor, Dept of ECE, Hooghly Engg. & Technology College, Hooghly, India

²M.Tech student, Microwave & Communication Engg., MCKV Institute of Engineering, Howrah, India

Abstract-Orthogonal Frequency Division Multiplexing (OFDM) is a very effective field of research of wireless communication and also the high speed data transmission process in this system. The main drawback of OFDM system is high Peak - to - Average Power Ratio (PAPR). Due to high PAPR there is inefficient use of high power amplifier and this could limit transmission efficiency. Selected mapping (SLM) is one efficient technique which reduces the PAPR in transmission channel. The PAPR problem is more important in the uplink since the efficiency of power amplifier is critical due to the limited battery power in a mobile terminal. The probabilistic technique is to scramble an input data block of the OFDM symbols and transmit one of them with the minimum PAPR so that the probability of high PAPR can be reduced. While it does not suffer from the out-of-band power, the spectral efficiency decreases and the complexity increase as the number of subcarriers increases.

Keywords:- OFDM, PAPR, SLM, IFFT

I. INTRODUCTION

Several communication systems and techniques have been used for transferring data and information reliably at high speed over wireless channel. One such technique is Orthogonal Frequency Division Multiplexing (OFDM) used for high data rate wireless transmission. In OFDM, data bits are transmitted in parallel using various carriers. Although OFDM is a multicarrier technology, it is very efficacious in mitigating the effects of multipath delay spread over a wireless radio channel. However, a major drawback with OFDM is the high Peak-to-Average Power Ratio (PAPR) of the transmitted signal. The high PAPR mainly results from certain data sequences, such as those containing all zeros or all ones. Such OFDM signals with high peaks result in poor power efficiencies. In addition, high peaks cause problems such as inter-symbol interference (ISI) and out-of-band radiation. Hence, it is imperative to reduce these peaks in the transmission signals. Many PAPR reduction techniques have been proposed. These techniques can be mainly categorized into signal scrambling techniques and signal distortion techniques.

Signal scrambling techniques	Signal distortion techniques
Block coding	Signal clipping
Sub block coding	Peak windowing
Selective level mapping	Envelope scaling
Partial transmit sequence	
Interleaving	
Linear block coding	
Tone reservation	

II. ORTHOGONAL FREQUENCY DIVISION MULTIPLEXING (OFDM)

OFDM is simply defined as a form of multi-carrier modulation where the carrier spacing is carefully selected so that each sub carrier is orthogonal to the other sub carriers. Two signals are orthogonal if their dot product is zero. That is, two signals are taken and multiplied together. If their integral over an interval is zero, then two signals are orthogonal in that interval. Orthogonality can be achieved by carefully selecting carrier spacing, such as letting the carrier spacing be equal to the reciprocal of the useful symbol period. As the sub carriers are orthogonal, the spectrum of each carrier has a null at the center frequency of each of the other carriers in the system. This results in no interference between the carriers, allowing them to be spaced as close as theoretically possible. Mathematically, suppose there is a set of signals Ψ and let Ψ_p be the p th element in the set. Then,

$$\int_a^{a+t} \Psi_p(t) \Psi_q(t) = k \text{ for } p = q$$

$$= 0 \text{ for } p \neq q \quad (1)$$

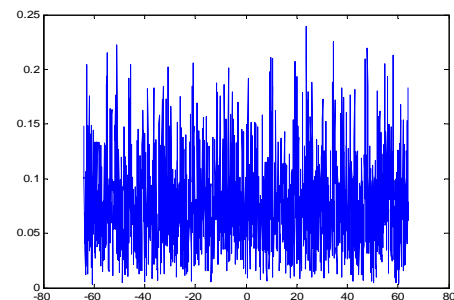

Figure 1: Simulation result of time domain OFDM

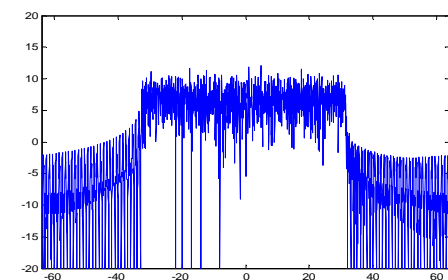

Figure 2: Simulation result of frequency domain OFDM

III. PEAK TO AVERAGE POWER RATIO (PAPR)

OFDM has its major benefits of higher data rates and better performance. High data rates are achieved by the use of multiple carriers and performance improvement is caused by the use of guard interval thus mitigating ISI. Apart from these basic benefits, it also increases spectral efficiency and minimizes multipath distortion. Although the use of multiple carriers is quite handy, it is accompanied by a lot of implementation problems like major one being the high Peak to Average Power Ratio (PAPR) of OFDM systems. It is given as:

$$\text{papr} = \frac{\max [x(t)x^*(t)]}{E[x(t)x^*(t)]} \quad (2)$$

Where $x(t)$ denotes the pass band signal whose PAPR is to be calculated. Expressing in decibels,

$$\text{papr}_{\text{dB}} = 10 \log_{10}(\text{papr}) \quad (3)$$

The subsystems used in communication are linear over a limited range. The more frequently used is HPA at the transmitter end to increase the transmitted power. However, the OFDM receiver detection is degraded severely by the use of non-linear amplifiers so HPA should not be used at full capacity but should be backed off to the limited linear range. PAPR limits DAC and ADC at transmitter and receiver end respectively. It increases Signal to Quantization Noise Error; this has to be increased to tackle the quite high peak powers. One way to minimize is the use of logarithmic quantizer which reduces it to some extent by smaller step sizes for higher amplitudes. This is good as the probability of getting higher power decreases as the power is increased. This probabilistic behavior is discussed in detail in the work to follow. However for the best performance, more advanced ways are used.

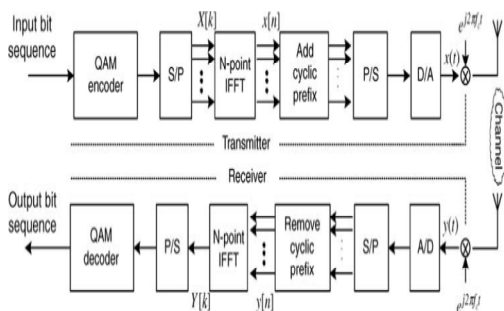

Figure 3:-Block diagram of OFDM system.

IV. PAPR OF SINGLE SINE TONE

Consider a sinusoidal signal $x(t) = \sin(2\pi ft)$ having the period T . The peak value of the signal is $\max [x(t)x^*(t)] = +1$. The mean square value of the signal is,

$$E[x(t)x^*(t)] = \frac{1}{T} \int_0^T \sin^2(2\pi ft) dt = \frac{1}{2} \quad (4)$$

Given so, the PAPR of a single sine tone is,

$$\text{papr} = \frac{1}{\left(\frac{1}{2}\right)} = 2 \quad (5)$$

Figure 4: PAPR of a single sine tone

V. PAPR OF A COMPLEX SINUSOIDAL

Consider a sinusoidal signal $x(t) = e^{2\pi f t}$ having the period T . The peak value of the signal is $\max [x(t)x^*(t)] = +1$. The mean square value of the signal is,

$$E[x(t)x^*(t)] = \int_0^T e(4\pi f t) dt = 1 \quad (6)$$

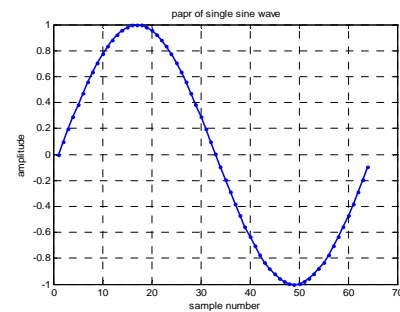
Given so, the PAPR of a single complex sinusoidal tone is, $\text{papr} = 1$.

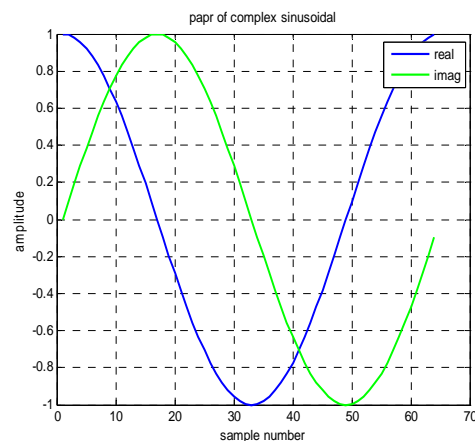

Figure 5: PAPR of a sinusoidal complex

VI. MAXIMUM EXPECTED PAPR FROM AN OFDM WAVEFORM

An OFDM signal is the sum of multiple sinusoidal having frequency separations $\frac{1}{T}$ where each sinusoidal gets modulated by independent information a_k . Mathematically, the transmit signal is,

$$x(t) = \sum_0^{K-1} a_k e^{j2\pi kt} \tag{7}$$

For simplicity, let us assume that a_k for all the subcarriers. In that scenario, the peak value of the signal is,

$$\begin{aligned} \max[x(t)x^*(t)] &= \max\left[\sum_0^{K-1} a_k e^{j2\pi kt} \sum_0^{K-1} a_k^* e^{-j2\pi kt}\right] \\ &= \max\left[a_k a_k^* \sum_0^{K-1} \sum_0^{K-1} e^{j2\pi kt} e^{-j2\pi kt}\right] \\ &= K^2 \end{aligned} \tag{8}$$

The mean square value of the signal is,

$$\begin{aligned} E[x(t)x^*(t)] &= E\left[\sum_0^{K-1} a_k e^{j2\pi kt} \sum_0^{K-1} a_k^* e^{-j2\pi kt}\right] \\ &= E\left[a_k a_k^* \sum_0^{K-1} \sum_0^{K-1} e^{j2\pi kt} e^{-j2\pi kt}\right] \\ &= K \end{aligned} \tag{9}$$

Given so, the peak to average power ratio for an OFDM system with K subcarriers and all subcarriers are given the same modulation is,

$$papr = \frac{K^2}{K} = K \tag{10}$$

It is reasonably intuitive that the above value corresponds to the maximum value of PAPR (when all the sub carriers are equally modulated, all the sub carriers align in phase and the peak value hits the maximum).we have used $K = 52$ sub carriers. Given so, the maximum expected PAPR is 52 (around 17dB),the cumulative distribution of PAPR from each OFDM symbol, modulated by a random BPSK signal is obtained.

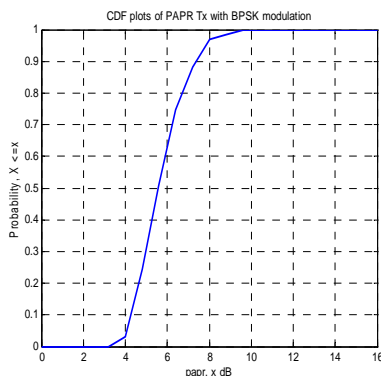

Figure 6: Cumulative distribution (CDF) plot of PAPR from a random BPSK signal

VII. SLM TECHNIQUE

In particular SLM technique whole set of signal represent the same signal but form it most favorable signal is chosen related to PAPR transmitted. The side information must be transmitted with the chosen signal. This technique is probabilistic based will not remove the peaks but prevent it from frequently generation. This scheme is very reliable but main drawback that is side information must be transmitted along with chosen signal.

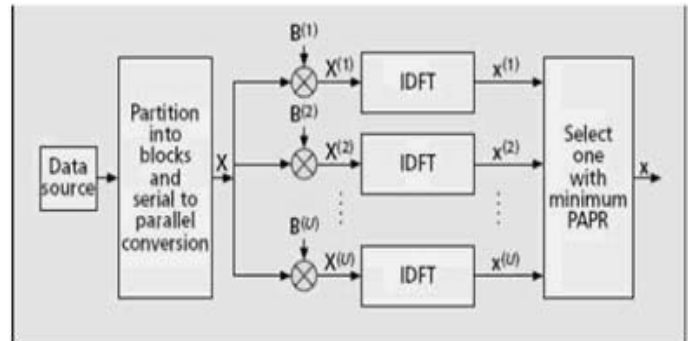

Figure 7 :-BLOCK DIAGRAM OF SLM SYSTEM

The input data sequences of each user $d^{(k)}=[d^{(k)}_1, d^{(k)}_2, \dots, d^{(k)}_M]$ with length M are first converted into M parallel data sequences $c^{(k)}=[c_1^{(k)}, c_2^{(k)}, \dots, c_L^{(k)}]$ and then each S/P converted output is multiplied with the spreading code with length L . Multiplexed symbol sequences $X = \sum_{k=1}^K X^{(k)} = [X_0, X_1, \dots, X_{N-1}]^T$ (11)

are multiplied by $U-1$ different phase sequences $b^M = [b_0^M, b_1^M, \dots, b_{N-1}^M]$ whose length is equal to the number of carriers before IFFT process resulting in $U-1$ modified data blocks

$$S = \sum_{u=0}^{U-1} X n b_n 2^u = [X_0 b_0^{(u)}, X_1 b_1^{(u)}, \dots, X_{N-1} b_{N-1}^{(u)}]^T \tag{12}$$

After the IFFT process, the PAPR is calculated for $U-1$ phase rotated symbols sequences

$$S(t) = \sum_{u=0}^{U-1} X n b_n^u = [X_0 b_0^{(u)}, X_1 b_1^{(u)}, \dots, X_{N-1} b_{N-1}^{(u)}]^T \tag{13}$$

and one original sequence and then the symbol sequence with lowest PAPR is selected for transmission and the corresponding selected phase sequence

$$\begin{aligned} \{\sim b(0), \sim b(1), \dots, \sim b(U-1)\} &= \arg.\min\{\sim b(1), \\ &\quad \sim b(2), \dots, \sim b(U-1)\} \tag{14} \\ &= (\max_{0 \leq n \leq N-1} |\sum_{M=0}^{U-1} b^u X_n^{(u)}|) \tag{15} \end{aligned}$$

is also transmitted to the receiver side for transmission .

VIII. FLOW CHART OF SLM TECHNIQUE

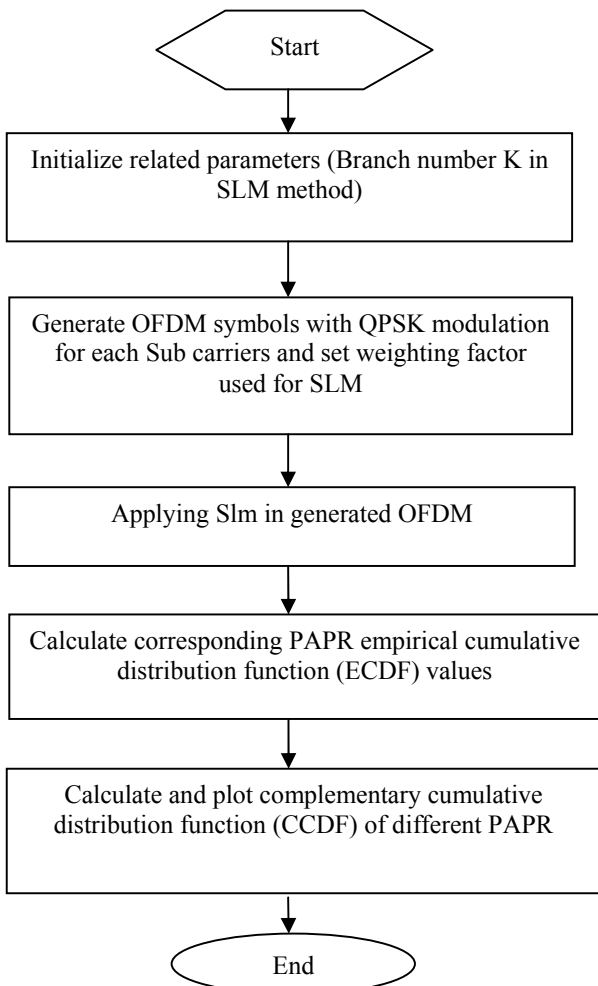

Figure 8:-flow chart used for PAPR reduction technique in SLM TECHNIQUE

IX. SIMULATION RESULT

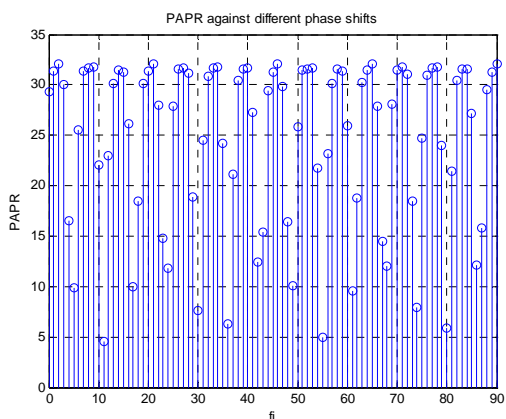

Figure 9:the PAPR of the OFDM

Here SLM technique used for reducing the PAPR of OFDM System with Phase Rotation with 16 sub carriers

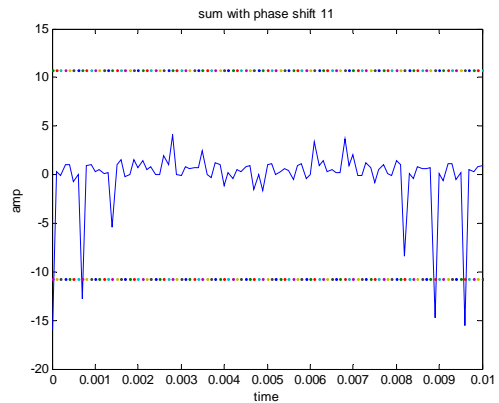

Figure 10:The 11 degree phase shift for reducing the PAPR

This figure shows the 11 degree is the optimum phase shift and that gives the least PAPR with value 4.5292db. Another observation by SLM technique is the PAPR reduction of OFDM system in presence of BPSK modulated sub carriers. Here the Phase rotation by multiplying all the sub carriers. In the sum by different phases to create a new data vector not only that but also as we do not know the optimum phase to give the best PAPR .We create more than one vector and then select the optimum.

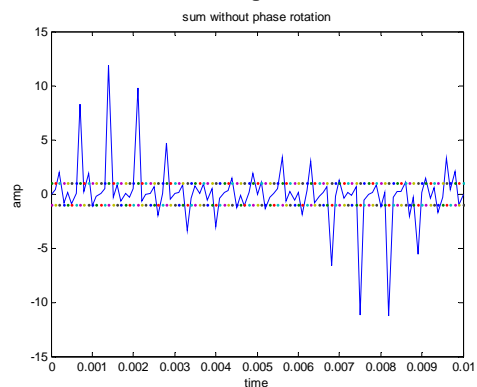

Figure 11:without Phase shift

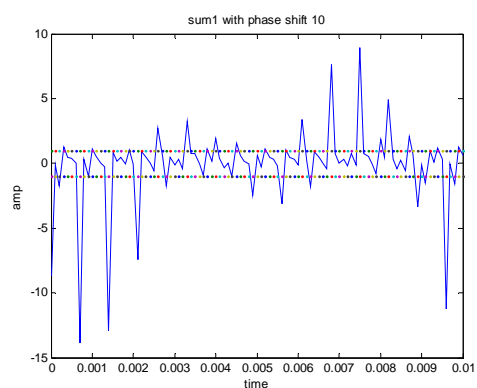

Figure 12:with phase shift 10

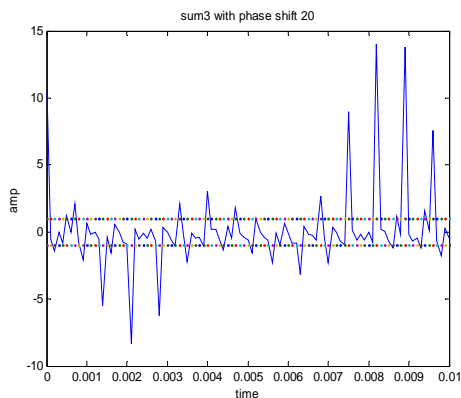

Figure13:with Phase shift 20

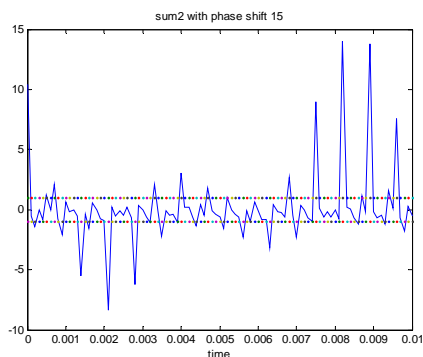

Figure14:with Phase shift 25

At last selector test the PAPR for the available data vectors and select the one with the least PAPR to use in transmitter.

X. CONCLUSION

OFDM is a very attractive technique for multi carrier transmission and has become one of the standard choices for high – speed data transmission over a communication channel. It has various advantages; but also has one major drawback: it has a very high PAPR.

We have also aimed at investigating some of the techniques which are in common use to reduce the high PAPR of the system. Among the three techniques that we took up for study, we found out that SELECTIVE MAPPING results. In this article SLM TECHNIQUE of reduction of PAPR is analyzed and its effects are considered.

. REFERENCES

[1] X. Li, L.J. Cimini, “Effects of clipping and filtering on the performance of OFDM,” *IEEE Com. Letters*, Vol. 2, No. 5, pp. 131-133, May 1998.
 [2] R. W. Bami, R. F. H. Fischer, and J. B. Hber, “Reducing the peak-to-average power ratio of Multicarrier modulation by selected mapping,” *IEE Electron, Lett*, vol. 32, pp. 2056–2057, Oct. 1996.
 [3] E. Telatar, “Capacity of multi-antenna Gaussian channels,” *European Transactions on Telecommunications*, vol. 10, no 3, Dec 1999.
 [4] Foschini G J, Gans M J, “On limits of wireless communication in a fading environment when using Multiple antennas,” *Wireless Personal Communication*, vol. 6.
 [5] J. A. Davis and J. Jedwab, “Peak-to-mean power control in OFDM, Golay complementary sequences and reed-muller codes,” *IEEE Trans. Inform. Theory*, vol. 45, pp. 2397–2417, Nov. 1997.

[6] V. Tarokh and H. Jafarkhani, “On the computation and reduction of the peak-to-average power ratio in multicarrier communications,” *IEEE Trans. Commun.*, vol. 48, pp. 37–44, Jan. 2000.
 [7] S. H. Muller and J. B. Huber, “OFDM with reduce peak-to-average power ratio by optimum combination of partial transmit sequences,” *Electron. Lett.*, vol. 33, no. 5, pp. 368–369, Feb. 1997.
 [8] R. W. Bauml, R. F. H. Fisher, and J. B. Huber, “Reducing the peak-toaverage power ratio of multicarrier modulation by selected mapping,” *Electron. Lett.*, vol. 32, no. 22, pp. 2056–2057, Oct.

BIOGRAPHY



Biswajit Basak received the M.E. degree in CSE from WBUT in 2007. He worked as Asst. Professor in Hooghly Engineering & Technology College, Hooghly, W.B, India. His research interest include VLSI Design, Wireless Communication. He has published quite a few Research papers in International conferences. For further correspondence his email is biswajitbsk@yahoo.co.in



Mousumi De received the B.E. degree in AEIE from the Burdwan University of Golapbag, Burdwan, WB, India, in 2010, the final year of M.TECH pursuing in ECE from the WBUT, WB, India. Her research areas include Wireless Communication. For further correspondence his e-mail is mou.de3@gmail.com